

W 6007-2RS1

Dimensions

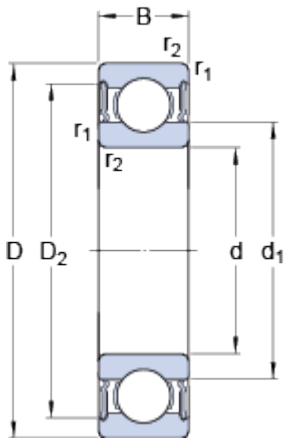

d	35	mm
D	62	mm
B	14	mm
d ₁	≈ 44	mm
D ₂	≈ 57.05	mm
r _{1,2}	min. 1	mm

Abutment dimensions

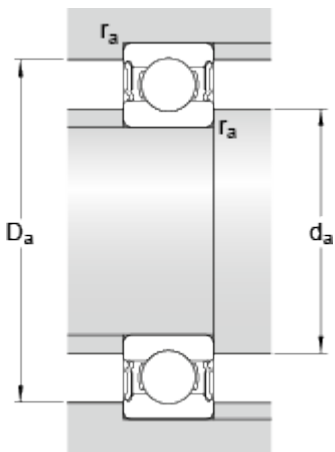

d _a	min. 40	mm
d _a	max. 43.5	mm
D _a	max. 57.5	mm
r _a	max. 1	mm

Calculation data

Basic dynamic load rating	C	13.8	kN
Basic static load rating	C ₀	10.2	kN
Fatigue load limit	P _u	0.44	kN
Reference speed		0	r/min
Limiting speed		6700	r/min
Calculation factor	k _r	0.03	
Calculation factor	f ₀	14.9	

Mass

Mass bearing	0.15	kg
--------------	------	----