

# W 6302-2RS1

## Dimensions

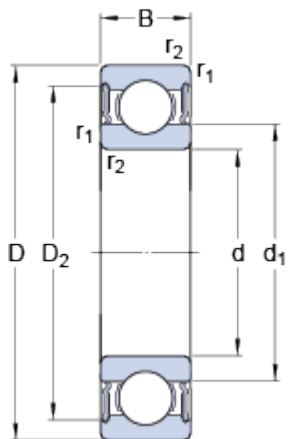

d	15	mm
D	42	mm
B	13	mm
d <sub>1</sub>	≈ 24.5	mm
D <sub>2</sub>	≈ 36.8	mm
r <sub>1,2</sub>	min. 1	mm

## Abutment dimensions

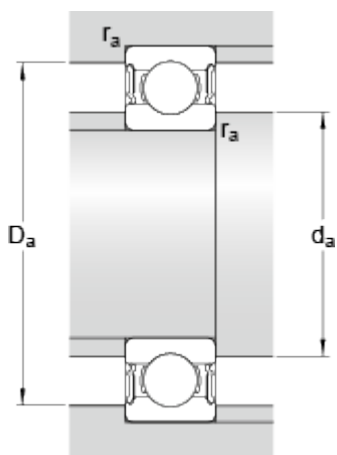

d <sub>a</sub>	min. 20	mm
d <sub>a</sub>	max. 24	mm
D <sub>a</sub>	max. 37.5	mm
r <sub>a</sub>	max. 1	mm

## Calculation data

Basic dynamic load rating	C	9.95	kN
Basic static load rating	C <sub>0</sub>	5.4	kN
Fatigue load limit	P <sub>u</sub>	0.232	kN
Reference speed		0	r/min
Limiting speed		11000	r/min
Calculation factor	k <sub>r</sub>	0.035	
Calculation factor	f <sub>0</sub>	12.3	

## Mass

Mass bearing	0.081	kg
--------------	-------	----