

W 6002-2Z

Dimensions

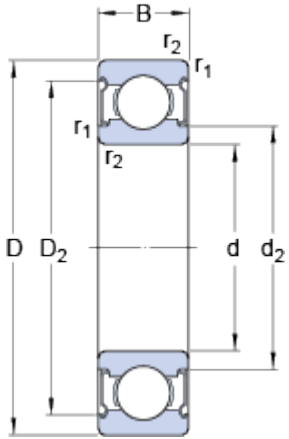

d	15	mm
D	32	mm
B	9	mm
d ₂	≈ 18.6	mm
D ₂	≈ 29.05	mm
r _{1,2}	min. 0.3	mm

Abutment dimensions

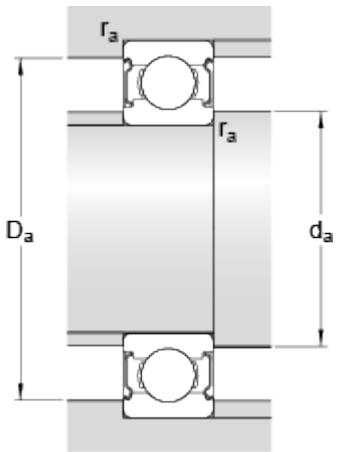

d _a	min. 17	mm
d _a	max. 18.5	mm
D _a	max. 30	mm
r _a	max. 0.3	mm

Calculation data

Basic dynamic load rating	C	4.88	kN
Basic static load rating	C ₀	2.8	kN
Fatigue load limit	P _u	0.12	kN
Reference speed		50000	r/min
Limiting speed		26000	r/min
Calculation factor	k _r	0.03	
Calculation factor	f ₀	13.9	

Mass

Mass bearing	0.029	kg
--------------	-------	----