

# W 6002

## Dimensions

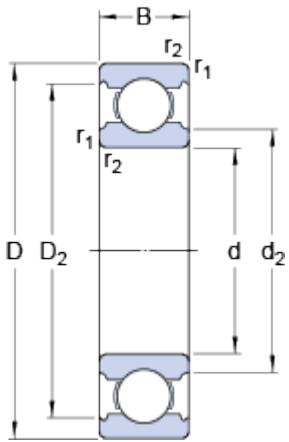

d	15	mm
D	32	mm
B	9	mm
d <sub>2</sub>	≈ 18.6	mm
D <sub>2</sub>	≈ 29.05	mm
r <sub>1,2</sub>	min. 0.3	mm

## Abutment dimensions

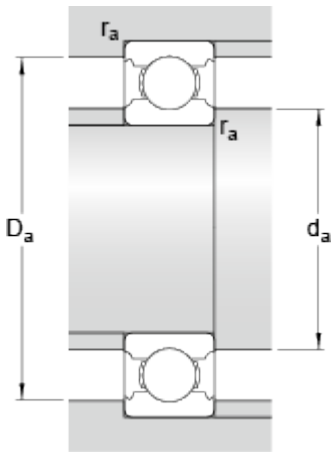

d <sub>a</sub>	min. 17	mm
d <sub>a</sub>	max. 18.5	mm
D <sub>a</sub>	max. 30	mm
r <sub>a</sub>	max. 0.3	mm

## Calculation data

Basic dynamic load rating	C	4.88	kN
Basic static load rating	C <sub>0</sub>	2.8	kN
Fatigue load limit	P <sub>u</sub>	0.12	kN
Reference speed		50000	r/min
Limiting speed		32000	r/min
Calculation factor	k <sub>r</sub>	0.03	
Calculation factor	f <sub>0</sub>	13.9	

## Mass

Mass bearing	0.027	kg
--------------	-------	----